

Name	VS44_0243 500x300 44 Weston		
Zeichnung/Drawing	3D		
Profil/Profile	4.4x13.5	Datum/Date	17.12.2024

H = 1.700 m
TOTAL: 12.78 m²

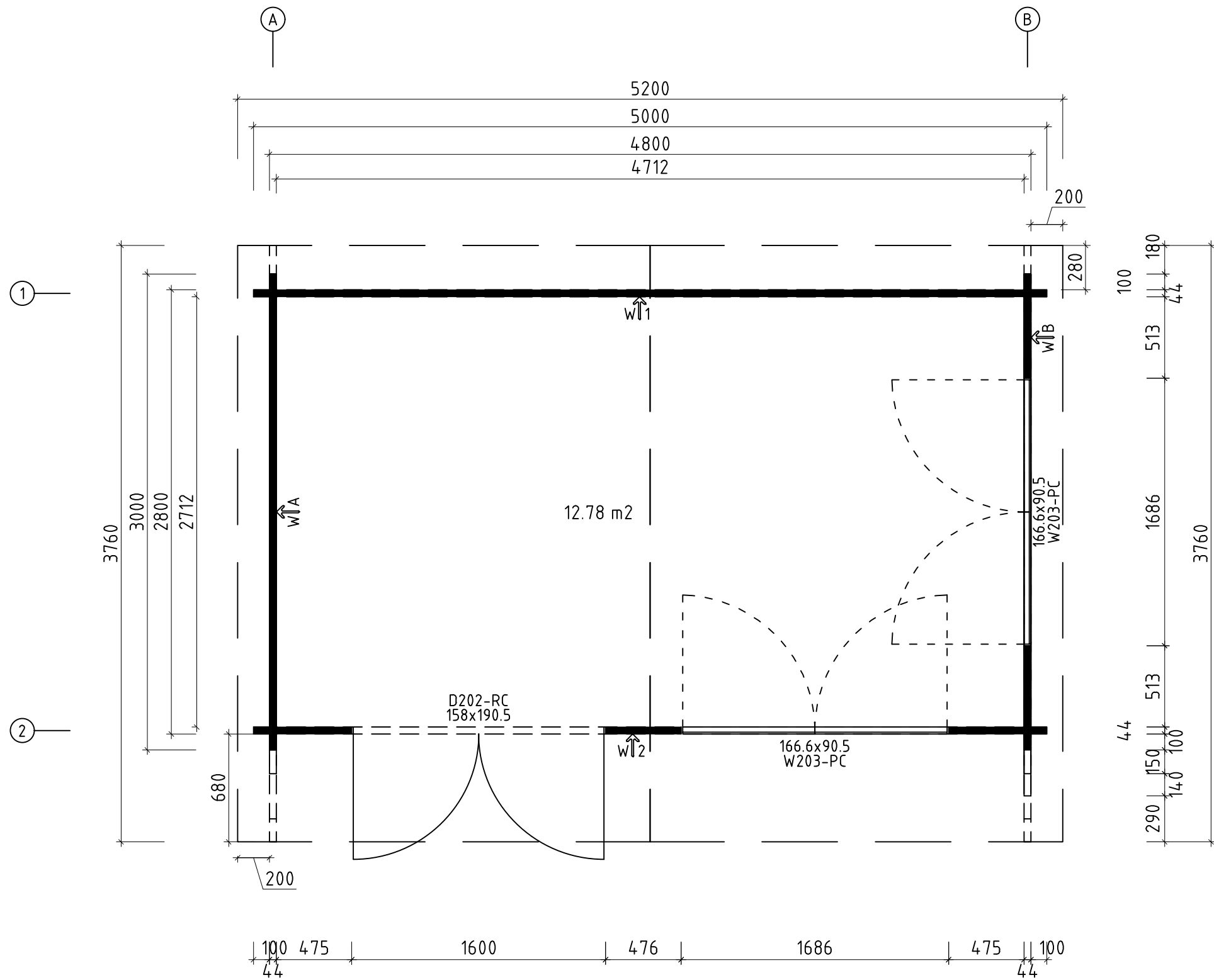

Q3 – Qualitätsklasse für Fenster und Türen/
Quality class for windows and doors

* Fenster und Türen sind mit Sprossen/
Windows and doors are with muntins

Name	VS44_0243 500x300 44 Weston		
Zeichnung/Drawing	Grundplan - Floor plan		
Profil/Profile	4.4x13.5	Datum/Date	17.12.2024

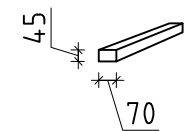
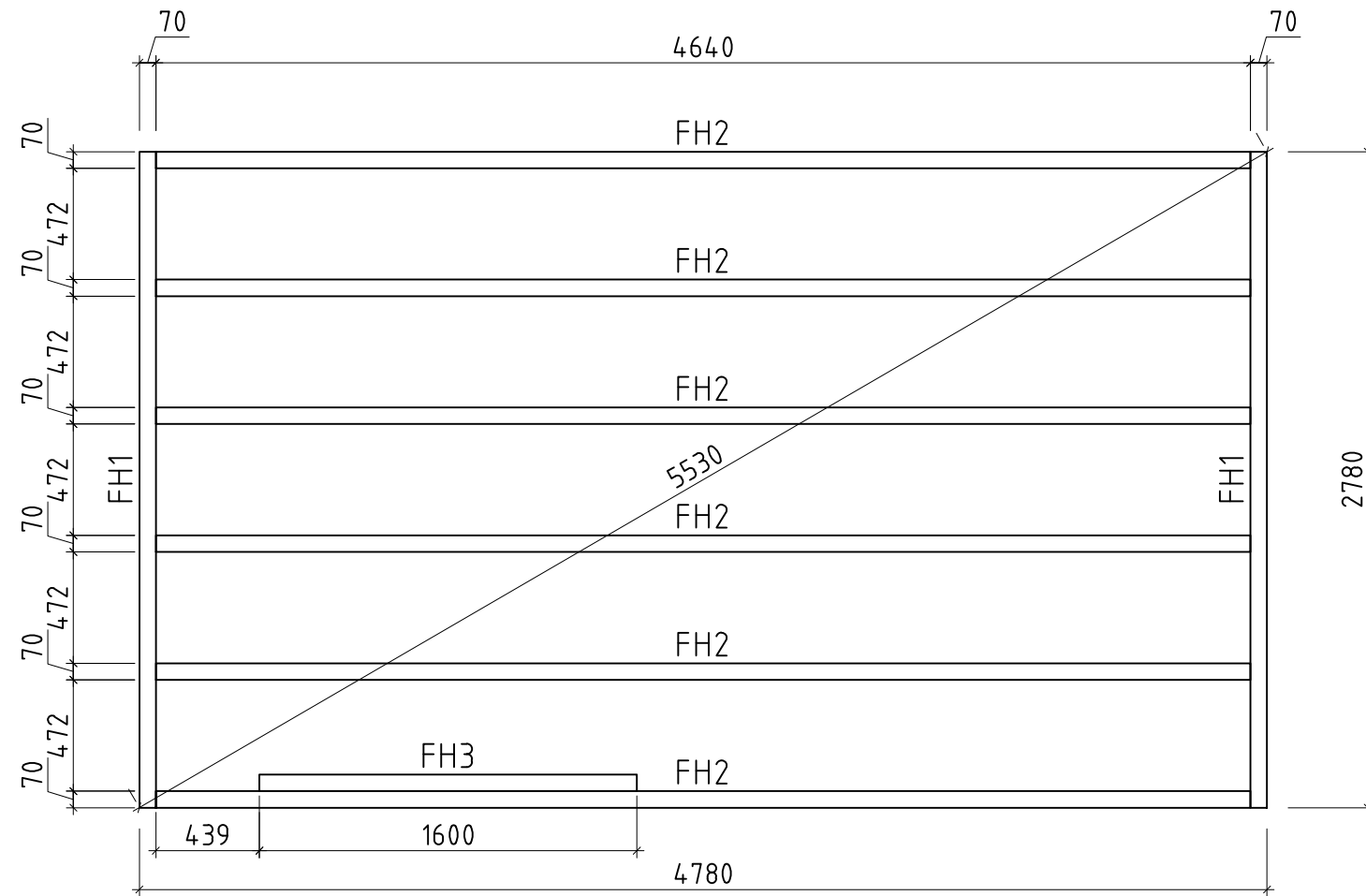

Name	VS44_0243 500x300 44 Weston		
Zeichnung/Drawing	Lagerholzplan - Foundation beam plan		
Profil/Profile	4.4x13.5	Datum/Date	17.12.2024

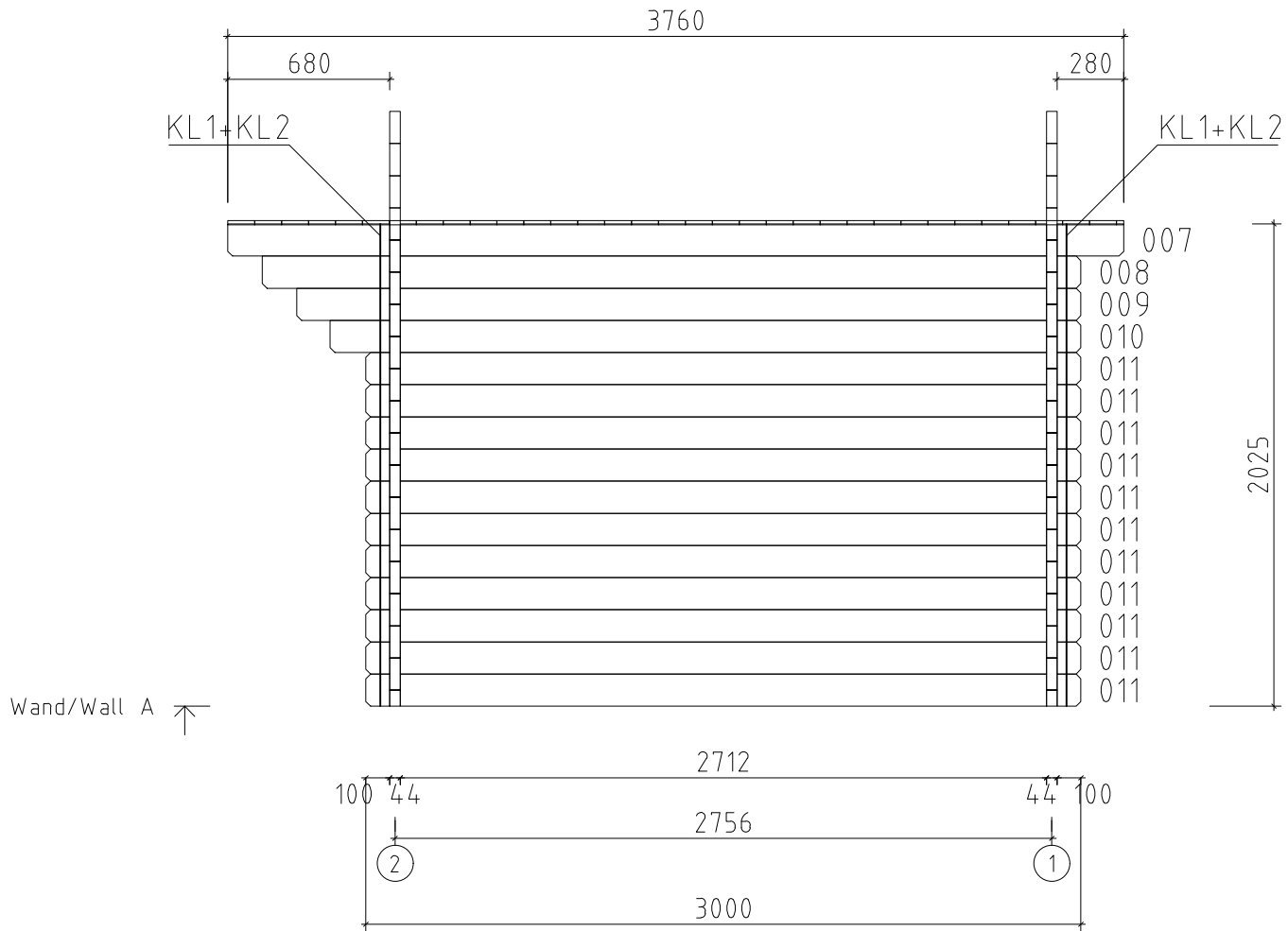

Name	VS44_0243 500x300 44 Weston	
Zeichnung/Drawing	WAND/WALL A	
Profil/Profile	4.4x13.5	Datum/Date 17.12.2024

- Giebeldeckleisten
- Gable cover strips
- Dachbretter
- Roof boards 18x113
- Giebelbretter
- Gable boards
- Pfetten/Wandbohlen
- Purlins/Wall log

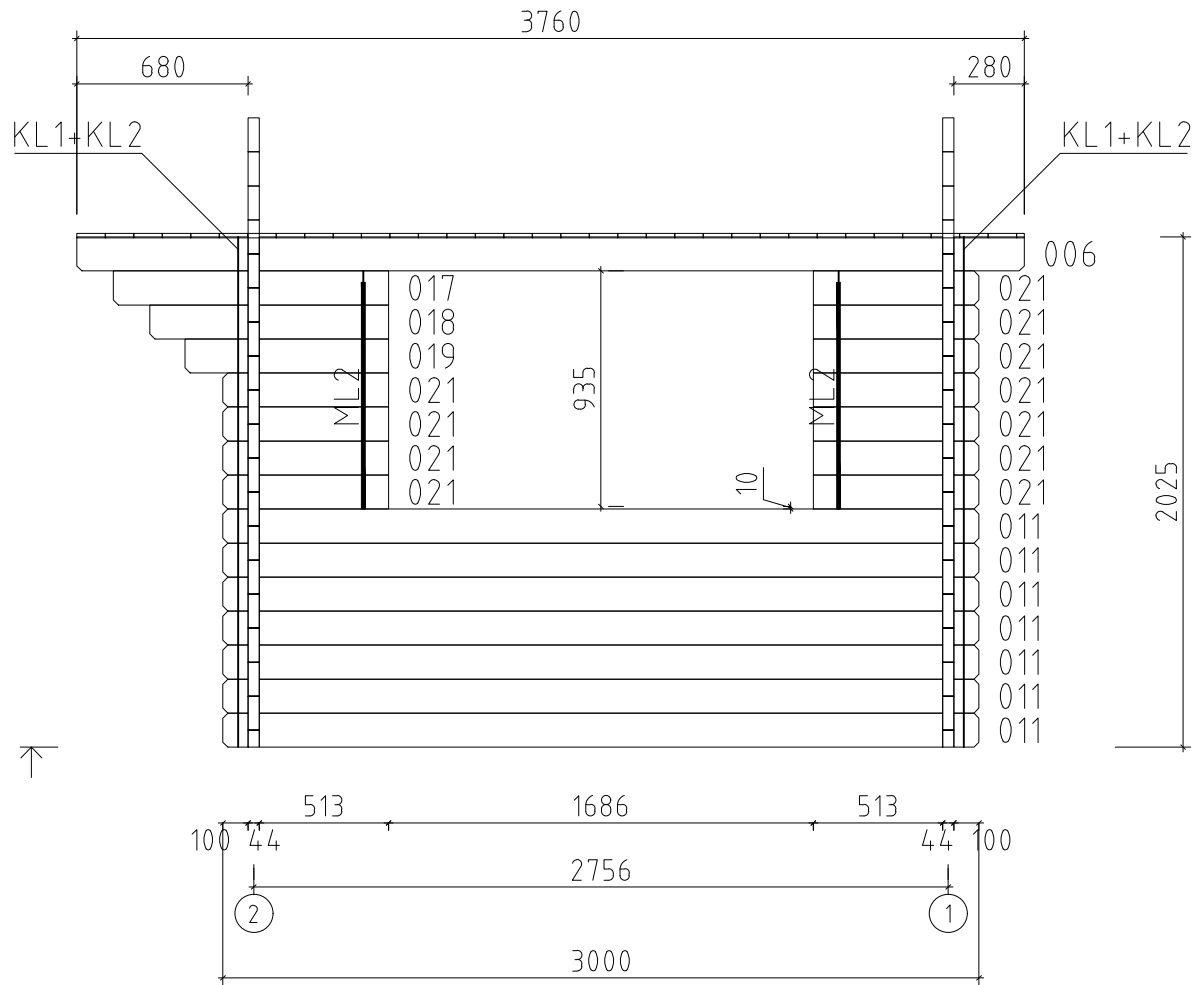

Wand/Wall B ↗

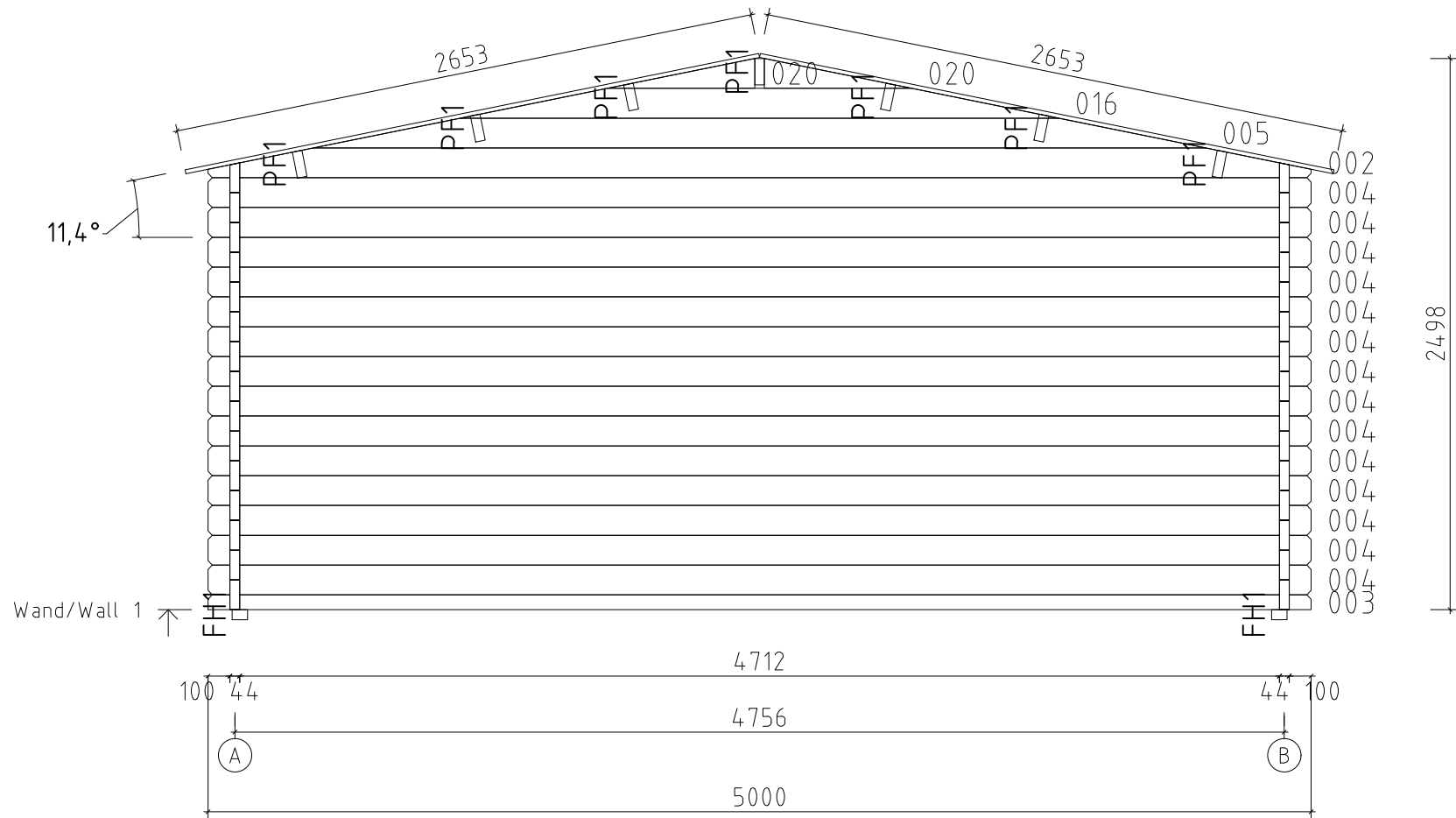

Name	VS44_0243 500x300 44 Weston	
Zeichnung/Drawing	WAND/WALL B	
Profil/Profile	4.4x13.5	Datum/Date 17.12.2024



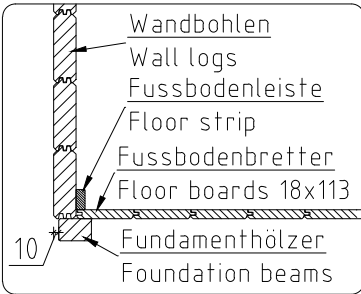
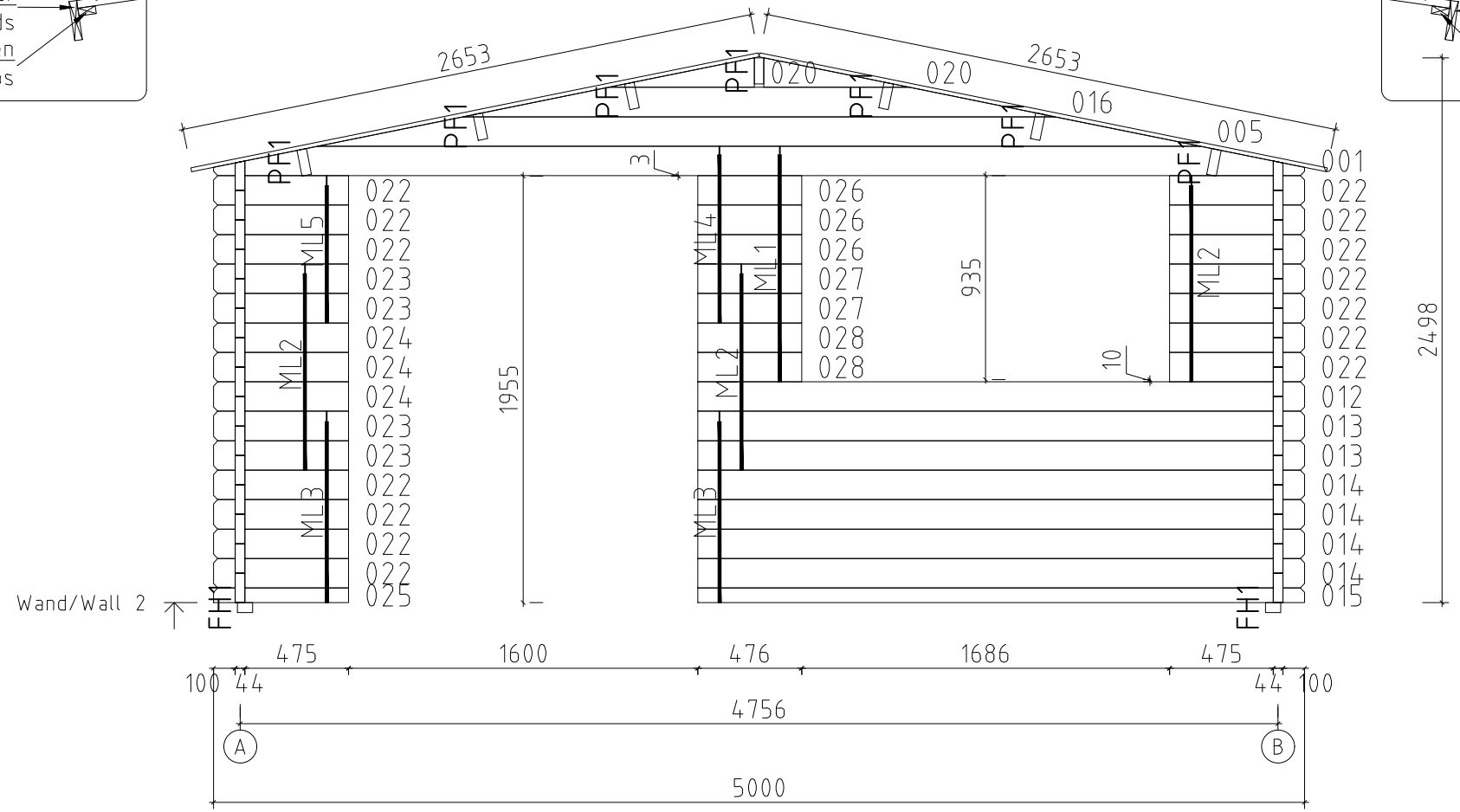
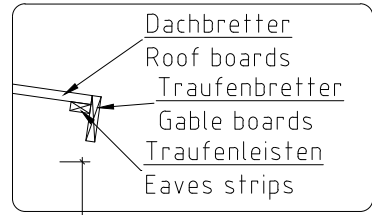
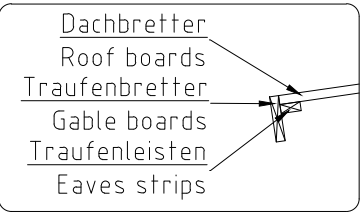



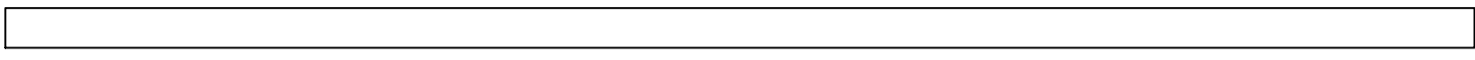
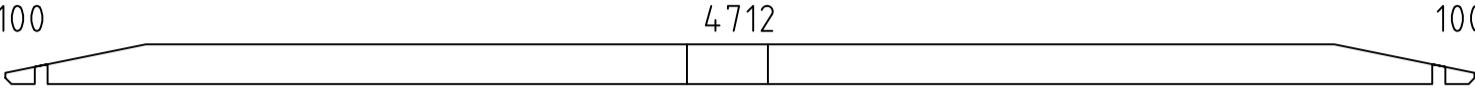
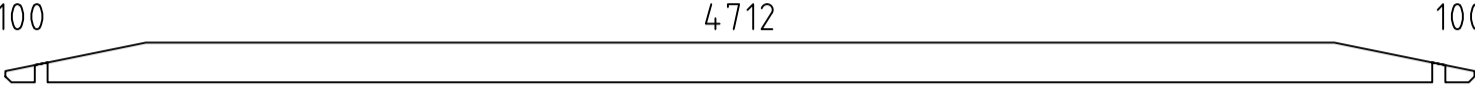
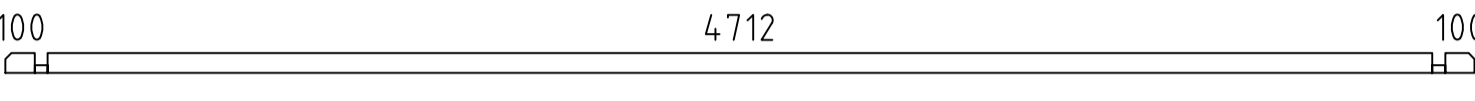
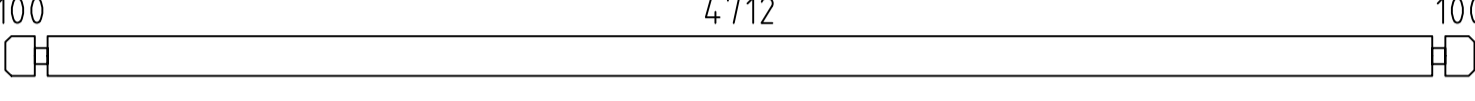
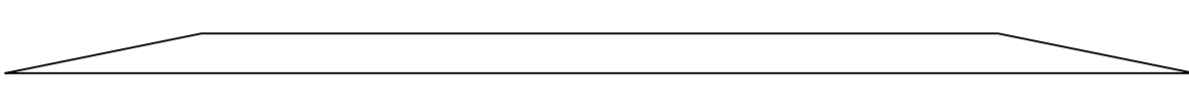
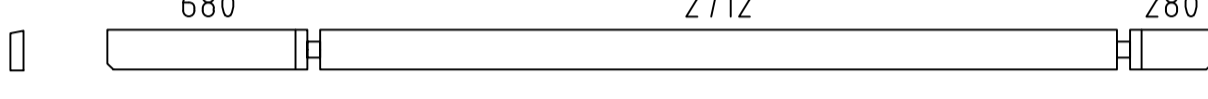
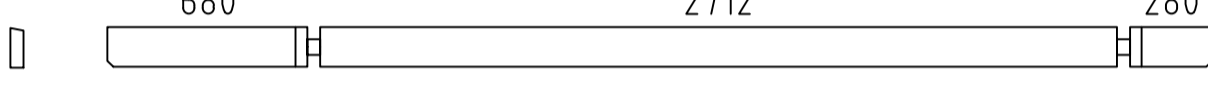
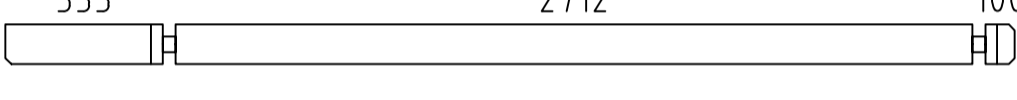
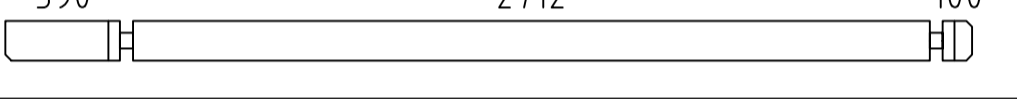
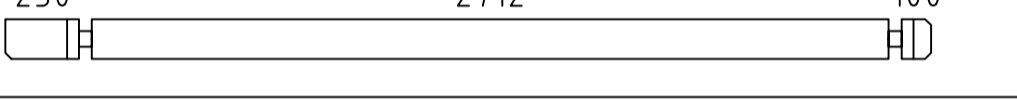
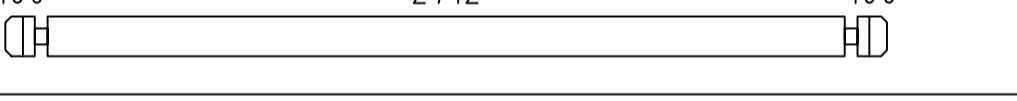
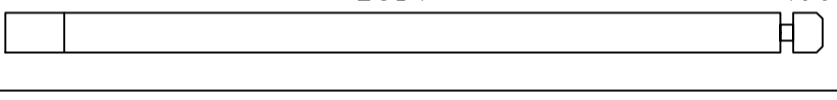
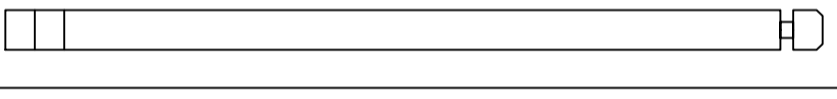
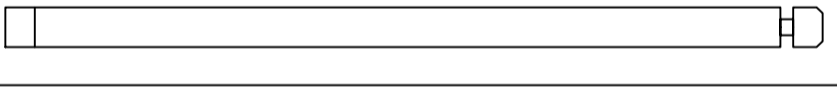
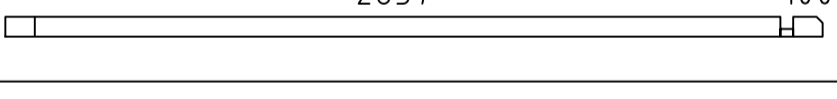

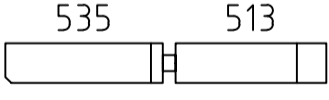
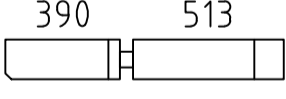
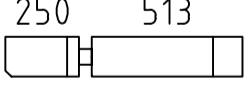
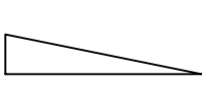
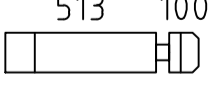
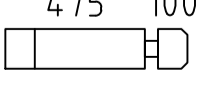
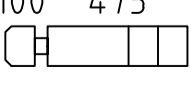
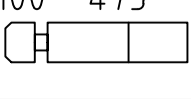

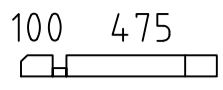
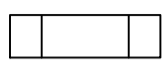
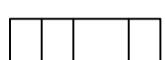
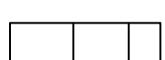
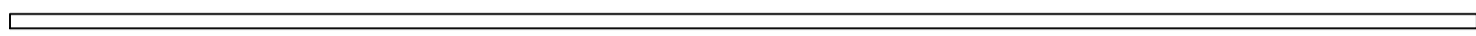
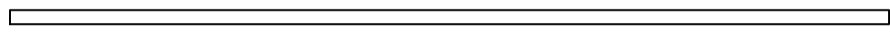
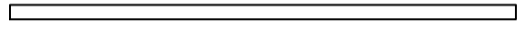
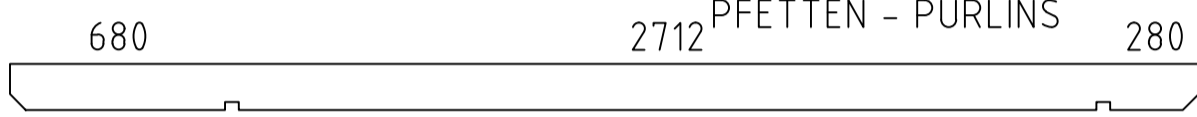
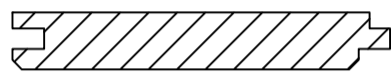
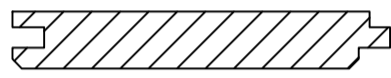
Name	VS44_0243 500x300 44 Weston		
Zeichnung/Drawing	WAND/WALL 1		
Profil/Profile	4.4x13.5	Datum/Date	17.12.2024

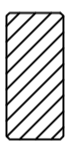
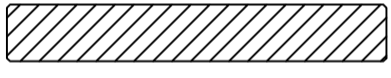
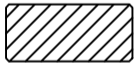
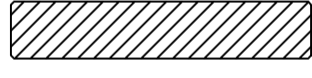
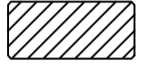
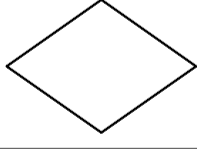
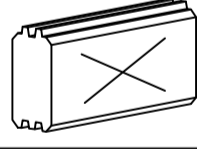

Name	VS44_0243 500x300 44 Weston		
Zeichnung/Drawing	WAND/WALL 2		
Profil/Profile	4.4x13.5	Datum/Date	17.12.2024

Pos	Teieliste/Specification VS44_0243 500x300 44 Weston	Stck Pcs.	Profil Profile (mm)	Länge Length (mm)
	<u>Achtung!</u> Die Giebelbohlen können teilweise schon vormontiert sein! Bitte beachten - diese erscheinen nicht ganz so wie in der Teieliste beschrieben.			
	<u>Notice!</u> The gable pieces can be partly pre-assembled! Please notice - those differ from the description given in the specification list.			
Extra1		1	44x135	5000
001		1	44x135	5000
002		1	44x135	5000
003		1	44x68	5000
004		14	44x135	5000
005		2	44x135	4045
006		1	44x135	3760
007		1	44x135	3760
008		1	44x135	3435
009		1	44x135	3290
010		1	44x135	3150
011		18	44x135	3000
012		1	44x135	2781
013		2	44x135	2781
014		4	44x135	2781
015		1	44x68	2781
016		2	44x135	2711
017		1	44x135	1092
018		1	44x135	947
019		1	44x135	807
020		4	44x135	667
021		11	44x135	657
022		14	44x135	619
023		4	44x135	619
024		3	44x135	619
Kood	VS44_0243 500x300 44 Weston	Materjal		Leht 1/5

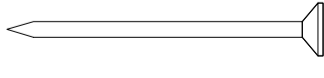
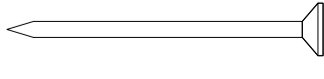
Pos	Teileliste/Specification VS44_0243 500x300 44 Weston		Stck./Pcs.	Profil/Profile (mm)	Länge/Len (mm)	
025			1	44x68	619	
026			3	44x135	476	
027			2	44x135	476	
028			2	44x135	476	
FH2	FUNDAMENTHOLZ (imprägniert) - FOUNDATION BEAM (impregnated) 		6	70x45	4640	
FH1	FUNDAMENTHOLZ (imprägniert) - FOUNDATION BEAM (impregnated) 		2	70x45	2780	
FH3	FUNDAMENTHOLZ (imprägniert) - FOUNDATION BEAM (impregnated) 		1	70x45	1600	
PF1	PFETTEN - PURLINS 		7	44x145	3760	
	DACHBRETTER - ROOF BOARDS		68+1	113x18	2653	
	FUSSBODENBRETTER - FLOOR BOARDS		42+1	113x18	2707	
	DECKENLEISTEN - CEILING STRIPS		✓	15x28	29.0 lfm/rm	
	FUSSBODENLEISTEN - FLOOR STRIPS		✓	18x40	17.0 lfm/rm	
G02-1	GIEBELBRETTER - GABLE BOARDS 18x120	11.4° 	✓	4	18x120	2733
G05-1	GIEBELDECKLEISTEN - GABLE COVER STRIPS 18x40		✓	4	18x40	2733
T01-1	TRAUFENBRETTER - EAVES BOARDS 18x95		2	18x95	3760	
T06-1	TRAUFENLEISTEN - EAVES STRIPS 18x40		✓	18x40	8.0 lfm/rm	
GS	GIEBELSEGMENT - GABLE DIAMOND		2			
SH	SCHLAGHÖLZER - MOUNTING PIECES		3			
ML1	Metallstange - Metal bar		1	D10	1040	
ML2	Metallstange - Metal bar		5	D10	900	
ML3	Metallstange - Metal bar		2	D10	830	
ML4	Metallstange - Metal bar		1	D10	770	
ML5	Metallstange - Metal bar		1	D10	630	
NG2 550	NÄGEL - NAILS 2.5x50 Dachbretter - Roof boards		680			
NG2 550	NÄGEL - NAILS 2.5x50 Fussbodenbretter - Floor boards		504			
Kood	VS44_0243 500x300 44 Weston		Materjal		Leht 2/5	

